

# SPECIFICATION FOR APPROVAL

## 產品確認書/製品仕様書

FILE SERIAL NO./檔序號:	XSG20230728001-T01
CUSTOMER / 客 戶:	
ARTICLE / 品 名:	SWITCHING POWER SUPPLY
MODEL NO. / 機種型號:	XSG2403000
PARAMETER / 規 格:	24.0V3.0A
CERTIFICATE/認證:	SAA,RCM,CE,CB,PSE,GS,UL,cUL,FCC,LVD,EMC,UKCA,KC
ISSUE DATE / 發行日期:	2023/7/28

Please to sign back after you confirm

承認書確認後請回簽一份

この仕様書をご確認とご署名の上、対象の営業窓口にご返信いただきますよう宜しくお願い致します。

CUSTOMER AUTHORIZED 客戶確認		
Approved by	Checked by	Prepared by

SUPPLIER AUTHORIZED 供方確認		
Approved by	Checked by	Prepared by
李麗敏	賀子豐	張文娟

\*感謝您的支持，我們十分珍惜每次合作機會

\*Thank you for your support,we will treasure the opportunity to cooperate with you

Rev.版本	Description of change/ 變更內容描述		Changed Date 日期	Approved
	Before(變更前)	After/變更後		
A	Original Release(初次發行)		2023/7/28	李麗敏



\* Make practical and safe power supply, Be enterprise with honesty and responsibility

\* 提供實用安全的電源，做誠信負責的企業

\* 実用的、安全な電源を提供し、誠実と信用、責任を持つ企業。



## ELECTRICAL PERFORMANCE / 電器性能

### 1.SAFETY STANDARD / 安規標準

- 1.1 The green mode power supply shall be certified by the following international regulatory standards: 充電器應符合下列的國際標準：

Certificate 證書	Country 國家	Standard/安規標準	Certificate 證書	Country 國家	Standard/安規標準
<input checked="" type="checkbox"/> UL/cUL	USA/CA 北美	UL62368-1;	<input checked="" type="checkbox"/> FCC	USA	FCC Part 15 Sub-part B
<input checked="" type="checkbox"/> LVD / UKCA	Eu / UK 欧盟 英国	BS EN 62368- 1:2014+A11:2017	<input checked="" type="checkbox"/> CE	Europe 歐洲	EN55032;EN55035; EN55024;EN61000; EN55022;
<input checked="" type="checkbox"/> CB	Global 全球	IEC62368;IEC61558; IEC60335;IEC60529	<input checked="" type="checkbox"/> KC	Korea 韓國	K60950-1
<input checked="" type="checkbox"/> PSE	Japan 日本	J62368;J60335	<input checked="" type="checkbox"/> SAA/RCM	AU 澳洲	AS/NZS 62368.1:2018 SAA-211032-EA
<input checked="" type="checkbox"/> GS	Germany 德国	EN 62368-1;EN61558 EN 60335	<input type="checkbox"/> CCC	CN 中國	GB 17625.1-2012;GB 4943.1-2011

### 2.INPUT FEATURE / 輸入特性

- 2.1 INPUT VOLTAGE RANGE: 90Vac to 264Vac. 輸入電壓範圍可以從90Vac到264Vac.
- 2.2 RATED INPUT VOLTAGE: 100Vac to 240Vac. 額定輸入電壓從100Vac到240Vac.
- 2.3 INPUT FREQUENCY RANGE: 47Hz to 63Hz. 輸入頻率範圍從47Hz到63Hz.
- 2.4 INPUT CURRENT: 3.0A max.&100-240Vac. 最大輸入電流3.0A (輸入條件100-240Vac)
- 2.5 INRUSH CURRENT: 45A max. at 100-240Vac input for a cold start at 25°C. 在准開機條件下，最大浪湧電流不超過45A (輸入條件100-240Vac).
- 2.6 EFFICIENCY: higher than 88% at 100-240Vac input and output full load. 效率高於88% (輸入100-240Vac 和輸出滿載條件)。
- 2.7 No-Load Input Power Dissipation/輸入空載功率損耗：Input 115Vac or 230Vac,output no load, the input power loss is less than 0.21W. 輸入115/230V交流，在空載時，輸入功耗

### 3.OUTPUT/輸出特性

RATED OUTPUT / 額定輸出	SPEC. LIMIT / 規格限定		REMARK / 備註
	Min. value	Max. value	
Output regulation / 輸出電壓規格	22.8VDC	25.2VDC	24V±5%
Output load / 輸出負載規格	0.0A	3A	Peak Current:3.6A
Ripple and Noise / 輸出紋波及雜訊	—	<200mVp-p	20MHz Bandwidth 10uF Ele. Cap.& 0.1uF Cer. Cap
Output Overshoot / 輸出過沖幅度	—	10%	
Line regulation / 電壓調整率	—	±1%	
Load regulation / 負載調整率	—	±3%	
Turn-on delay time / 開機延遲時間	—	3000mS	
Hold up time / 關機維持時間	10mS	—	Input voltage:115Vac
	20mS	—	Input voltage:230Vac

<b>EDITION</b>	<b>A</b>	<b>PAGE</b>	<b>3/10</b>
----------------	----------	-------------	-------------

## ELECTRICAL PERFORMANCE / 電器性能

### 4.4 IELECTRIC WITHSTANDING STRENGTH(HI-POT) / 絕緣介電強度 (耐壓)

Primary to Secondary AC3000V, 10mA,1 minute for type test, 3 second for production.  
一次側對二次側：AC3000V, 10mA標準測試1分種，量產測試3秒鐘。

### 5.PROTECTION FEATURE / 保護特性

#### 5.1 OVER—CURRENT PROTECTION / 過電流保護：

The green mode power supply shall be hiccup when any output operating in overload condition(set@ Max load 120~180% ) under any line condition for an indefinite period of time. The power supply shall be self — recovery when the fault condition is removed. 在任何時候任何輸入條件，當輸出操作在超載條件最大電源的（120~180%）時，電源供應器將進入打嗝模式，當故障被移走後，電源要能自動恢復到正常。

#### 5.2 SHORT—CIRCUIT PROTECTION / 輸出短路保護：

The power supply shall be hiccup and no damage shall occur when any output operating in a short circuit condition under any line condition for an indefinite period of time. The power supply shall be self—recovery when the fault condition is removed. 在任何時候，任何輸入條件下，當輸出操作在短路情況下，電源供應器將進入打嗝模式，當故障消失後，電源要能自動恢復正常。

### 6.ENVIRONMENTAL CONDITIONS / 環境條件

#### 6.1 OPERATING / 操作條件：

The power supply shall be capable of operating continuously in any mode without performance deterioration in the following environmental conditions. 在下列環境條件下，電源供應器要能夠連續操作在各種模式，且不能造成性能的退化。

6.1.1 **Operating Temperature: -20°C~40°C 工作溫度：-20°C~40°C**

6.1.2 **Relative Humidity: 10%~90% 相對濕度：10%~90%**

6.1.3 **Vibration: 1.0mm, 10—25Hz, 15 minutes per cycle for each axis (X, Y, Z)**

6.1.4 **Cooling: The power supply will operate with convection cooling. Blocking of vents must not cause damage to the power supply. 電源供應器將操作在對流冷卻的環境下，即使將通風口阻塞電源也不允許有任何損傷發生。**

#### 6.2 NON—OPERATING / 非操作條件：

The power supply shall be capable of withstanding the following environmental conditions extended periods of time, without sustaining electrical or mechanical damage and subsequent operational deficiencies.

電源供應器要能夠長期的經受下列的環境條件，且不允許有電氣級機械方面的損傷和併發的操作的缺失

6.2.1 **Storage Temperature: -30°C~70°C 儲存溫度：-30°C~70°C**

6.2.2 **Relative Humidity: 10%~90%相對濕度：10%~90%**

6.2.3 **Color of case and cable / 外殼及線材顏色：Black / 黑色**

<b>EDITION</b>	<b>A</b>	<b>PAGE</b>	<b>4/10</b>
----------------	----------	-------------	-------------

---

## ELECTRICAL PERFORMANCE / 電器性能

### 6.2.4 Vibration and Shock / 振動和衝擊

The power supply shall be designed to withstand normal transportation vibration per MIL—STD—810D,method 514 and procedures X, as it s mounted in the chassis assembly and packed for shipping.

電源供應器出貨的包裝設計，均要能承受正常運輸的振動，並符合MIL—STD—810D方法514 和程式 X。

## 7.EMC STANDARDS / 電磁相容性標準

### 7.1 EMI STANDARDS / EMI 標準

The power supply met the radiated and conducted emission requirements for FCC CLASS B, EN55032 CLASS B.

本電源供應器符合輻射及傳導要求，滿足FCC CLASS B, EN55032 CLASS B.

### 7.2 EMS STANDARDS / EMS 標準

The power supply shall meet the following EMS standards: 本電源供應器滿足下列EMS標

7.2.1 EN61000-4-2: 2009 / A1: 1998 Electrostatic Discharge(ESD)

7.2.2 EN61000-4-3: 2010 / A1: 1998 Radiated Electromagnetic Fields(RS)

7.2.3 EN61000-4-4: 2012 Electrical Fast Transient / Burst(EFT)

7.2.4 EN61000-4-5: 2014 Lighting Surge Attachment. Line to Neutral: 2KV

## 8 RELIABILITY AND QUALITY CONTROL / 可靠性及品質控制

### 8.1 BURN—IN / 老化

The power supply shall undergo a minimum of 4 hours Burn—In test under full load at 40<sup>o</sup>

電源應在40<sup>o</sup>C~±5<sup>o</sup>C和滿載條件下老化4小時。

### 8.2 COMPONENT DERATING / 元件溫度要求

Semiconductor junction temperatures shall not exceed the manufacturer's maximum thermal rating. 半導體結溫不允許超過其製造商要求的最大溫度值。

## 9.WEIGHT / 重量

The weight of the power supply shall be about 450g電源的重量大約為450g。

## 10.MECHANICAL REQUIREMENT / 結構參數

The power supply size: L137.5\*W56.5\*H35mm.外殼尺寸: L137.5\*W56.5\*H35mm

## 11.INSULATION RESISTANCE / 絕緣阻抗

Input to output: 50M OHM(500VDC)輸入對輸出50兆歐姆 (500VDC)

EDITION	A	PAGE	5/10
---------	---	------	------

---

## ELECTRICAL PERFORMANCE / 電器性能

### 12.LEAKAGE CURRENT / 漏電流

The leakage current shall be **less than 0.25mA for class II** when power supply is operated maximum input voltage and maximum load. 當電源供應器操作在最大輸入及最大負載情況下，其漏電流應 **小於0.25mA, 滿足class II等級**。

### 13.MAJOR MEASURE EQUIPMENT / 主要測量設備; VERIFIED BY THE THIRD LAB/外校

- A AC SOURCE / AC變頻電源: 固緯/GWINSTEK APS-7100E,校準頻次: 1次/年  ✓
- B DIGITAL POWER METER / 數字功率計功率儀: 固緯/GWINSTEK GPM-8213,校準頻次: 1次/年  ✓
- C ELECTRONIC LOAD / 開編程電子負載儀: 美爾諾/MAYNUO M9713,校準頻次: 1次/年  ✓
- D OSCILLOSCOPE / 存儲示波器: 泰科/TEKTRONIX TBS1102B,校準頻次: 1次/年  ✓
- E DIGITAL MULTIMETER / 數字式萬用表: 福祿克(FLUKE) F12E+校準頻次: 1次/年  ✓
- F DC POWER / 直流電源: 麥創 (MATRIX) MPS-6030D校準頻次: 1次/年  ✓
- G HIPOT AND INSULATION RESISTANCE TESTER / 耐壓安規測試儀:  
固緯/GWINSTEK GPT-9803 ,校準頻次: 1次/年  ✓
- H NSULATION RASISTANCE TESTER / 絕緣電阻表: YD2681A,校準頻次: 1次/年  ✓
- I MULTI CHANNEL TEMPERATURE SENSOR / 多路溫度測試儀  
艾維泰科/IVYTECH IV380-16校準頻次: 1次/年  ✓

EDITION	A	PAGE	6/10
---------	---	------	------

## DC CORD / 輸出線材

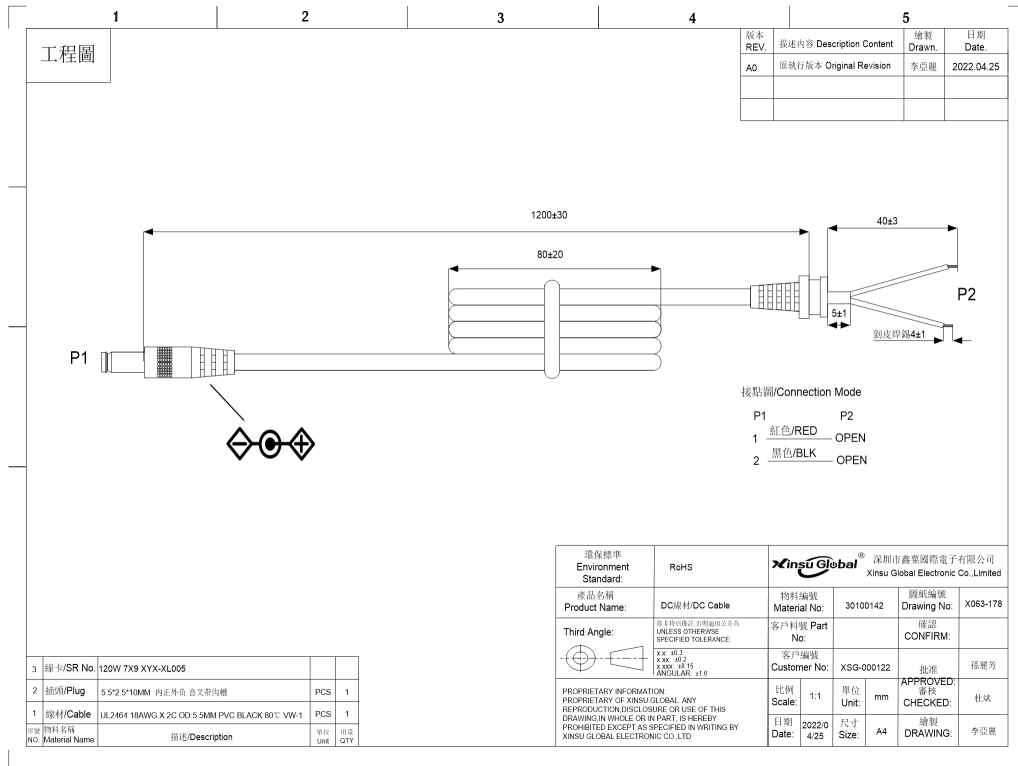

Cable Specification/線材規格		
UL2464 Round Wire, 18AWG*2C L=1.2M Black 80°C,300V		
Item No	Part Name ( 部件名稱 )	Description ( 描述 )
A	Length of DC cord(DC線長度)	1.2M
B	Size of DC connector ( DC頭尺寸 )	5.5*2.5*10mm直頭內正外負，音叉帶溝槽。
C	Length of coil ( 線包長度 )	70MM±10
D	SR NO(線卡編號)	XYX-XL005
E	Length of inlet wire ( 出線長度 )	30MM±1
F	Tinned length ( 吃錫長度 )	4MM±1

EDITION	A	PAGE	7/10
---------	---	------	------

# AC CORD/输入线材

Version: 版本: A	Customer: 鑫聚	Customer P/N: X16001	Customer: 鑫聚
Drawing NO: 图号	X16001	Customer P/N: ACH电源线	Customer: 鑫聚

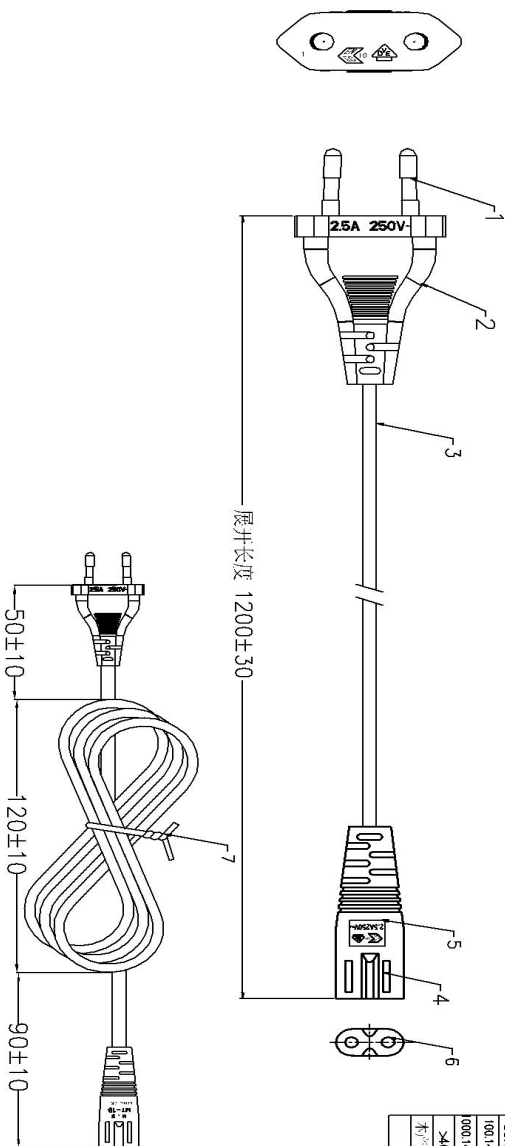

本图由计算机自动生成	
尺寸范围	公差尺寸
1~6	±1
6.1~10	±2
10.1~20	±3
20.1~50	±4
50.1~100	±8
100.1~1000	±15
1000.1~10000	±40
>10000	±100
本图由计算机自动生成	REACH

线材 KEMA-KEUR VDE REC 60227-5 300/300V H03VH2-F 2X0.75mm<sup>2</sup> CABO  
 印字 FLEXIVEL PLANO IEMMEQU ++++++ N14440 NEW SQUARE

7	导线 (Wire & cable)	黑色	包PVC绝缘线	1	140	
6	插座端子 (Terminal of end plug)			2		磷铜色
5	插座脚套 (Type of end plug)	MT-18<2.5A 250V>ENEC>	BK001 89A PVC	1		黑色
4	尾帽护套	八字尾帽套	黑色	1		
3	线材绝缘 (Cord specification)	VDE H03VH2-F 2X0.75mmSQ	BK001 80A PVC	1	1185±8	黑色
2	插头脚套 (Type of plug)	MT-11<2.5A 250V>ENEC>	BK001 89A PVC	1		黑色
1	插头五金 (Pin of plug)	欧式架五金	黑色	1		镀锌



标题	更改内容	工程
Draw: ZHAN	日期	2015-10-06
Unit: 单位	批准	

赣州永德电业制品有限公司

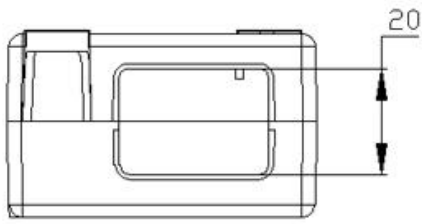

PRODUCT OUTLINE DIMENSION / 產品外觀尺寸

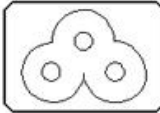
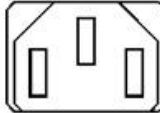
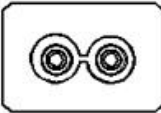

AC Inlet Type	IEC 320-C6	IEC 320-C14	IEC 320-C8
AC入力コネクタ			
AC輸入類型			

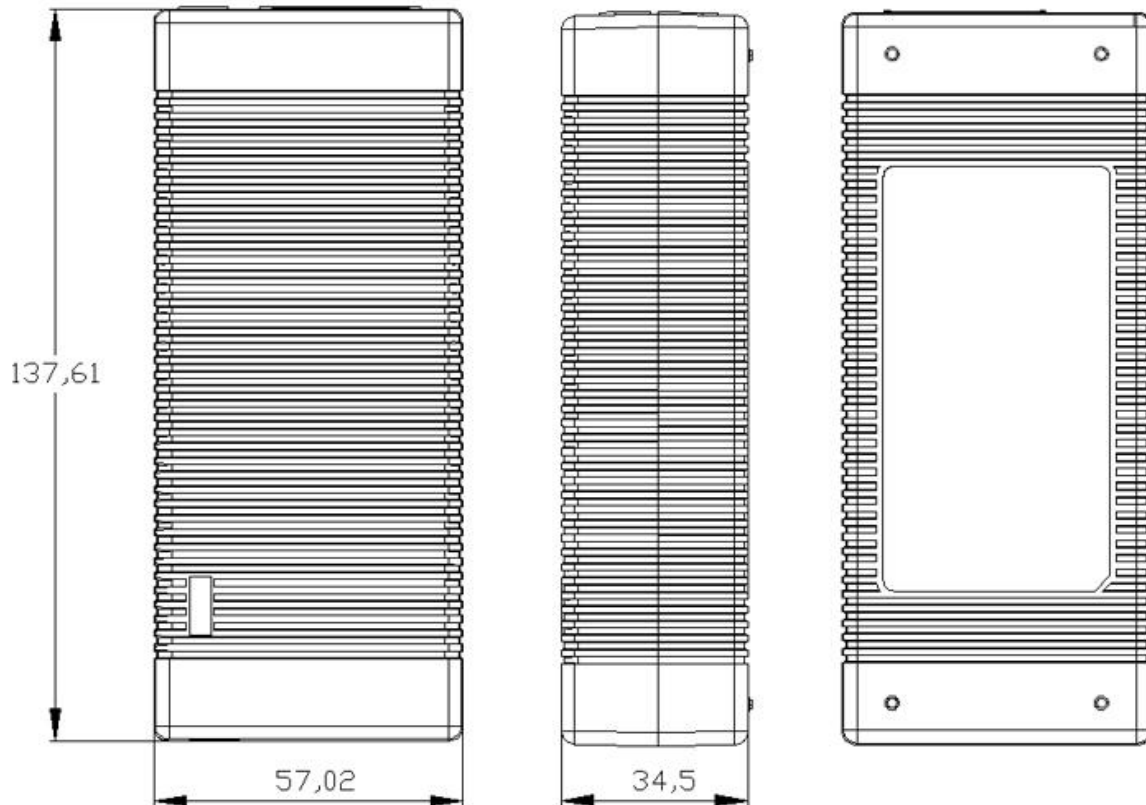

Material/材料: PC

Brand/品牌: SABIC / 沙伯

Fireproof Class/防火等級: UL94V-0

Color/顏色: Black/黑色



EDITION	A	PAGE	9/10
---------	---	------	------



RATING LABEL / 銘牌

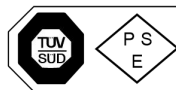

**Xinsu Global®**

**SWITCHING POWER SUPPLY**  
(スイッチング電源)

MODEL(品番): XSG2403000  
 INPUT(入力): 100-240V~50/ 60Hz 3.0A  
 OUTPUT(出力): 24.0V  $\equiv$  3.0A 72.0W 

  
  

Xinsu Global 株式会社



직류전원장치  
 부품명: XSG2403000  
 정격입력: 100-240 V~, 50/60 Hz, 2.5 A  
 정격출력: 24.0V  $\equiv$  3.0A 72.0W  
 HU10934-18004B      A/S: 02-926-9084

ROHS

 EFFICIENCY

**CAUTION:**  
**RISK OF ELECTRIC SHOCK**  
**DRY LOCATION USE ONLY**  
 乾燥している場所でのみ使用してください  
 MADE IN CHINA      DATE CODE: XXXXXX  
 XINSU GLOBAL ELECTRONIC CO., LIMITED

标贴仅供参考

Print/印刷

Laser Carving/鐫雕

1. Silver text on black background 黑底銀字
2. Material: PET 底材為消銀龍.
3. Clear Printing, Wipe Resistance 絲印清晰，耐擦拭.
4. Gum Permanent 永久背膠.
5. Meet Requirements of Environmental Protection 符合環保要求

<b>EDITION</b>	<b>A</b>	<b>PAGE</b>	<b>10/10</b>
----------------	----------	-------------	--------------